

G.T.trading reserves the right to make modifications or improvements to the products illustrated without notice thereof - The availability of the products illustrated is subject to change - The products described in this User's Guide represent just a part of the **AUDIO SYSTEM** products available - All brands and trademarks mentioned have been used exclusively for description purposes and all rights belong to the respective owners - Total or partial reproduction of this User's Guide is prohibited.

AUDIO
SYSTEM
Italy

F2D-1000

USER'S GUIDE
Two-channel car audio
power amplifier

product concept
engineering
production
distribution

GTtrading
CAR & HOME AUDIO HI-FI EQUIPMENT

ITALY
www.gt-trading.it

TWISTER
SERIES

HIGH GRADE SOUND PERFORMANCE AMPLIFIER



INTRODUCTION

GTtrading thanks you for your purchase, and would like to congratulate you on choosing an **AUDIO** product.

Twister series amplifiers guarantee superior performance levels in terms of electrics, mechanics and sound, keeping the characteristics stated constant through time. GTtrading wishes you happy listening.

The User's Guide

The user's guide was devised to facilitate the correct installation procedure so that you get the most out of your new amplifier. It contains information and vital procedures for the correct operation of the product and any devices connected to it.

The "Safety Measures General Rules" manual should be considered an integral part of this document. It is essential that all recommendations are observed in order to guarantee the safety of those responsible for installing and/or using the product.

Safety

The manuals contain information that is useful for installing and tuning the product. Nevertheless, it is recommended that these operations be performed by qualified persons only.

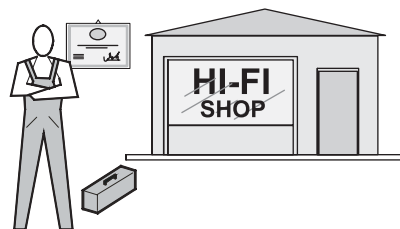
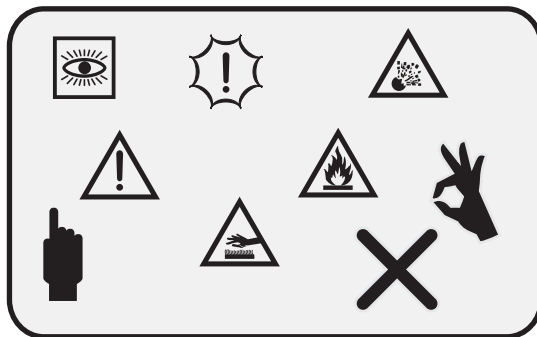
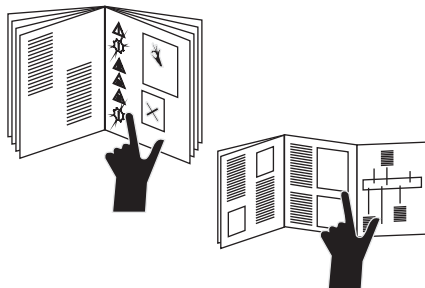

CONTENTS

INTRODUCTION	1
PRODUCT DESCRIPTION	3
Packaging and contents	4
General description	4
Input	4
Crossovers	4
Output	5
Power supply	5
Remote control	5
TECH. SPECIFICATIONS	6
MEAS. CONDITIONS	6
BLOCK DIAGRAM	7
DIMENSIONS	7
FASTENING	7
CONTROL PANEL	8-10
Power supply/more funct.	8-10
Speaker	11
CONNECTIONS	12
Power supply	12
Speaker	13
Output load impedance	14
Passive filters	14
ADJUSTMENTS, USE	15
First usage	15
Indicator LEDs	15
Sensitivity adjustment	16
CONFIGURATIONS	17-20
Suggestions	17-20
MAINTENANCE	21
Fuse replacement	21
After-sales Service	21
A.T.R.I.	21
Product identification	21
TROUBLESHOOTING	22
DIAGRAMS	23

PRODUCT DESCRIPTION

Packaging and contents

Kcompetition amplifiers are packed in a box designed to protect its contents. Do not damage or discard the packaging, but keep it for future use.

On receipt of the amplifier, check that:

the packaging is intact, the contents correspond to the specifications, the product has not been damaged in any way. In the event of missing parts, damages or other faults, report the latter to the Retailer you purchased it from immediately, making a note of the model and serial number of the amplifier.

- A:** Amplifier
F2D-1000
- B:** User's guide
- C:** Fastening screws
(4) PA4x20
- D:** Gold /Nickel plated Adapter
(2)

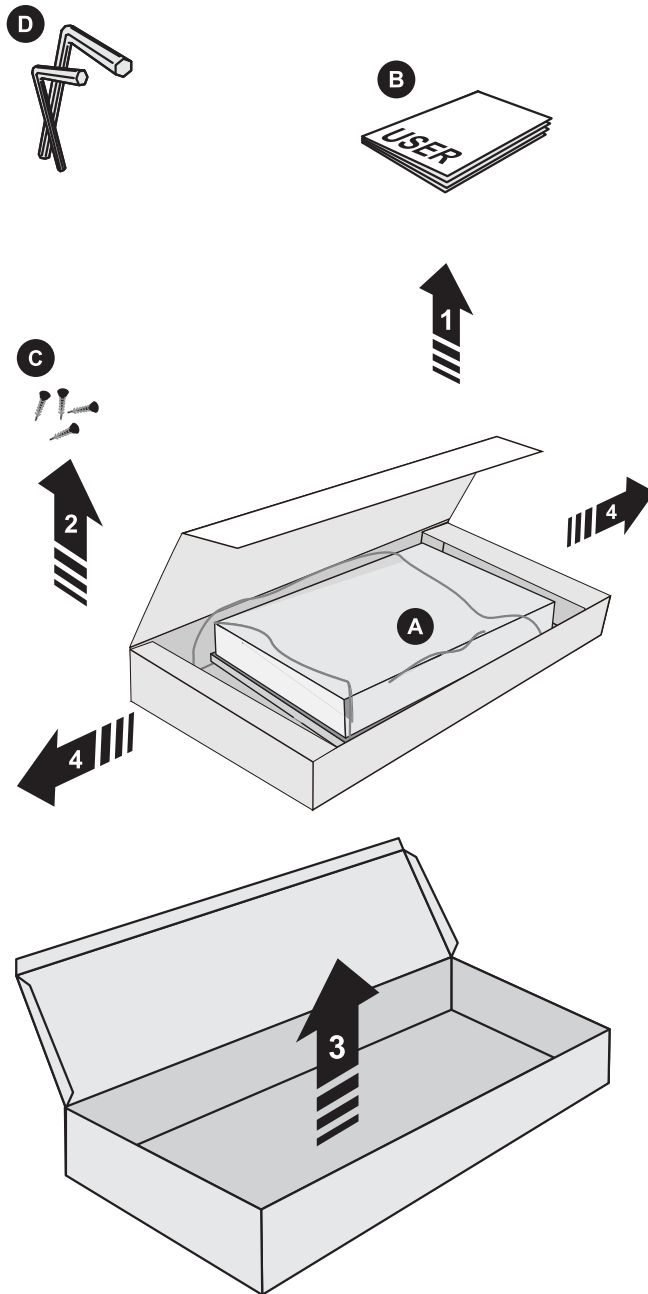

PRODUCT DESCRIPTION

General description

Twister series are stereo audio power amplifiers for car use, designed to amplify the signals reproduced by sources such as: tuners, cassette players, CD players, etc.

Input

The amplifier is divided up into two sections, "LOW INPUT" which both feature a stereophonic input "LEFT" and "RIGHT", for the connection of the signal generated by the source or any elaboration devices fitted.

Crossovers

The amplifier features filter devices that can limit the output frequency band. The various settings allow you to optimize the signal in order to drive different speaker models.

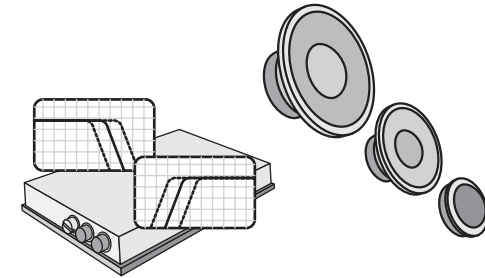
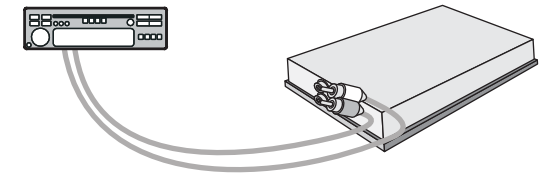
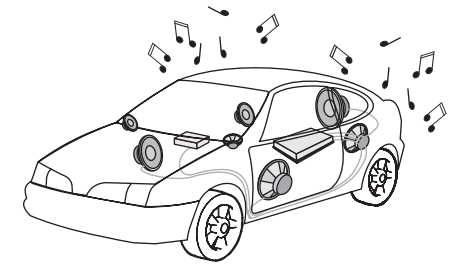

PRODUCT DESCRIPTION

Output

The loudspeaker system has to be connected to the terminals “+” and “-” of “LEFT” and “RIGHT” power outputs. According to the connections, the three basic configurations are obtained:

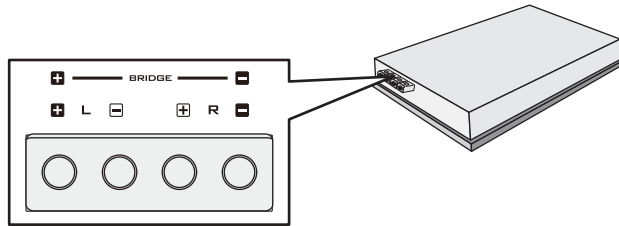

STEREO

BRIDGED MONO

TRIMODE

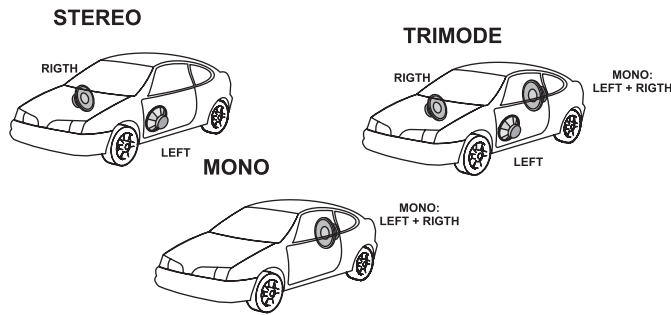

Power supply

The POSITIVE cable of the battery, the EARTH cable and the REMOTE cable that allows for switch-on to be synchronised with the source are all connected to the power supply section of the amplifier.

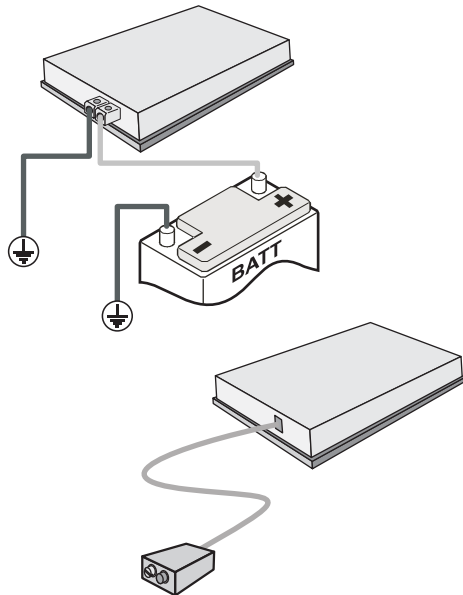

Remote control

It is possible to connect **AUDIO** remote tuning devices to the amplifier's “REMOTE CONTROL” connector. These devices offer an effective means of modifying key listening parameters.

PRODUCT DESCRIPTION

F2D-1000

Power Supply

Power supply voltage

: 10 - 16 VDC

Amplifier Stage

<i>Output power (RMS) @ 14,4V / 4 Ω</i>	: 395 Watt x2
<i>Output power (RMS) @ 14,4V / 2 Ω</i>	: 650 Watt x2
<i>Output power (RMS) @ 14,4V / 4 Ω bridged</i>	: 1300 Watt x1
<i>Output power (max.) @ 14,4V / 4 Ω</i>	: 790 Watt x2
<i>Output power (max.) @ 14,4V / 2 Ω</i>	: 1300 Watt x2
<i>Output power (max.) @ 14,4V / 4 Ω bridged</i>	: 2600 Watt x1
<i>Distortion (THD)</i>	: <0,5%
<i>S/N Ratio</i>	: >85dB
<i>Channel separation</i>	: >65dB
<i>Input sensitivity</i>	: 800mV - 9,0V

Filters

<i>Low pass filter/slope</i>	: 40 Hz - 300 Hz / 12dB
<i>High pass filter/slope</i>	: 40 Hz - 300 Hz / 12dB
<i>Bass Boost Frequency</i>	: NC

Other Functions

<i>Fuse</i>	: NC
<i>Max size (W x H x L)</i>	: 380 x 194 x 55 mm

PRODUCT DESCRIPTION

BLOCKS DIAGRAMS

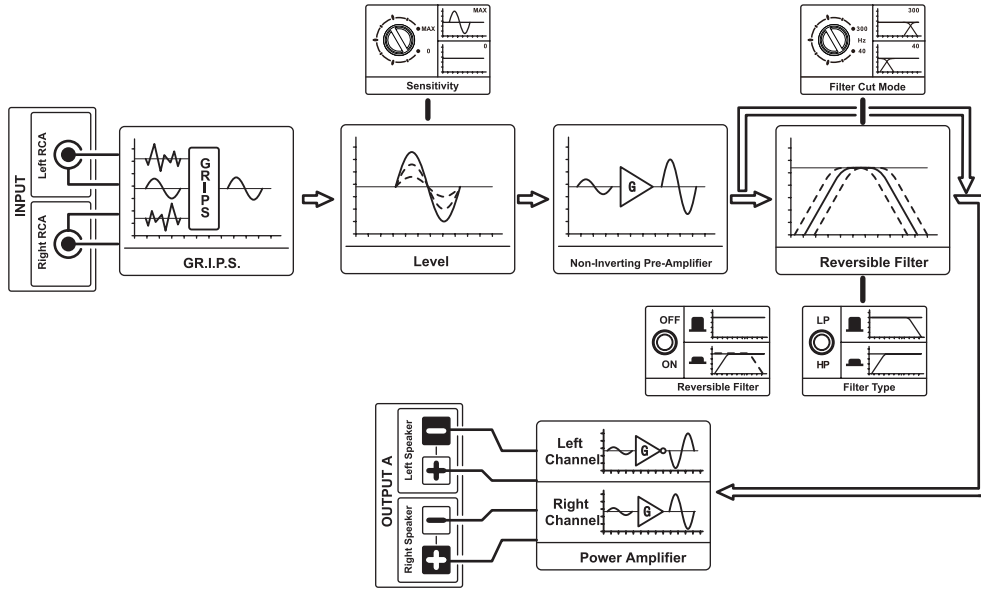

DIMENSIONS

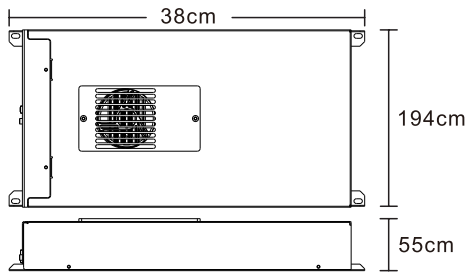

FASTENING

Fasten the feet securely to the amplifier and the amplifier to a surface designed to withstand its stresses, using all four slots foreseen. Tighten the fastening screws.



DAMAGE TO THE CAR COULD SERIOUSLY COMPROMISE THE SAFETY OF THE VEHICLE AND ITS PASSENGERS

CONTROL PANEL

Power supply/more functions

SPEAKER OUTPUT

The connector for the power outputs to which the speaker system must be connected.

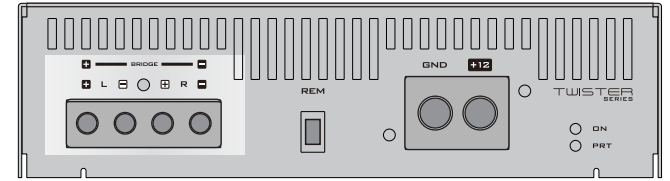

LEFT SPEAKERS

Connection of the Left-hand loudspeakers in Stereophonic configuration.

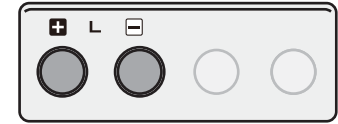

RIGHT SPEAKERS

Connection of the Right-hand loudspeakers in Stereophonic configuration.



BRIDGED MONO SPEAKERS

Connection of the loudspeakers in monophonic bridged configuration.



BRIDGE

POWER SUPPLY POSITIVE

POSITIVE connection of the power supply.

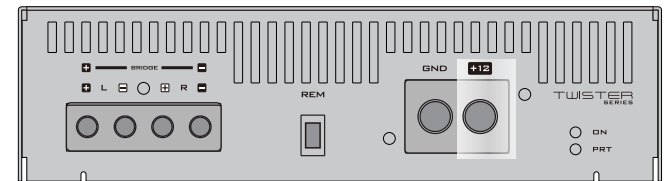

CONTROL PANEL

Power supply/more functions

POWER SUPPLY NEGATIVE

NEGATIVE connection of the power supply (Ground).

3

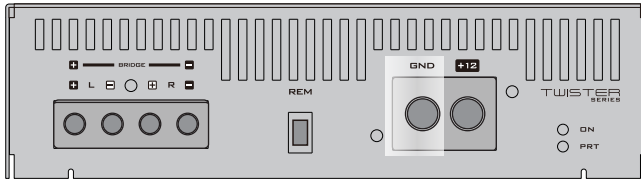

REMOTE CONTROL SOCKET

Connection of remote devices for remote control of listening functions.

4

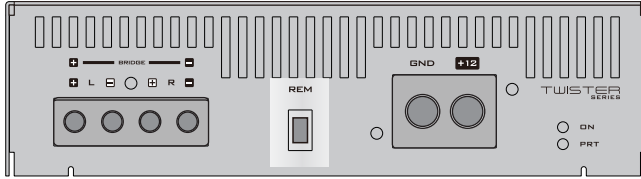

SATUS INDICATION

ON - OK
PRT - Error

5

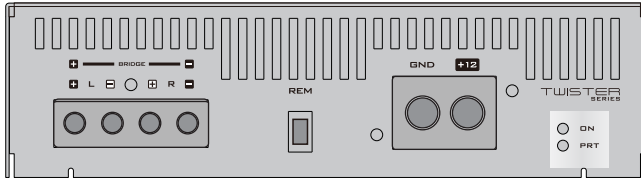

CINCH INPUTS

Terminal for connection of the RCA wires. To avoid failure, please use high quality RCA wires.

6

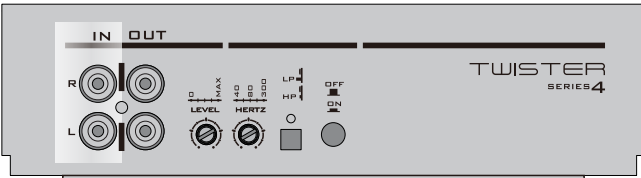

RCA OUTPUT BY-PASS SIGNAL

By connecting to the RCA "OUT PUT" jack, you can capture the Right Stereophonic and Left Stereophonic signals present at inputs and. In this way, it is possible to drive other amplifiers linked to the same audio system.

7

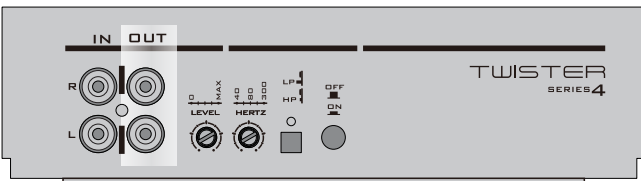

CONTROL PANEL

Power supply/more functions

INPUT LEVEL CONTROLLER

Sets the input sensitivity of the amplifier to adapt it to the level of the signal generated by the source.

8

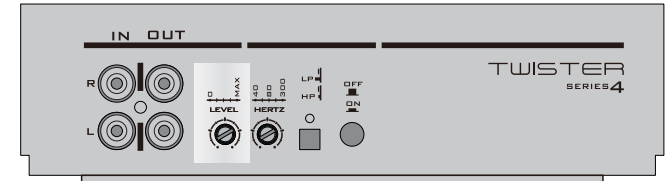

HIGH / LOW PASS CONTROLLER

Set the filter switch to "HIGH/LOW" position. Adjust the variable HPF crossover frequency to the desired frequency using the controller. All frequency between 40 and 300Hz will be reproduced.

9

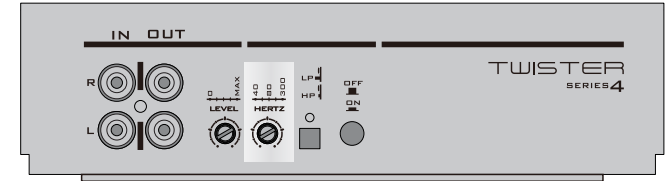

LP/ HP

HPF after push the button, LPF if no push.

10

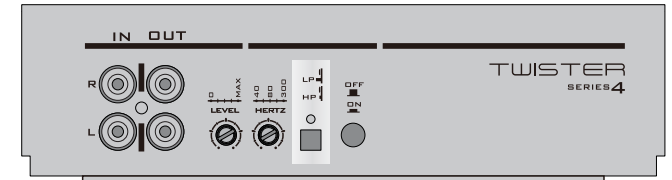

FILTER ON/OFF

HP & LP after push the button, Full pass if no push.

11

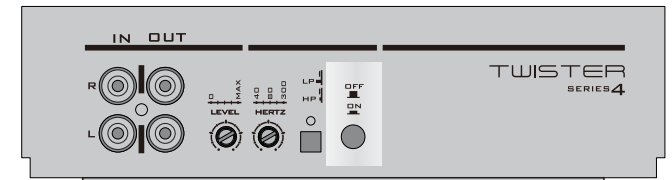

CONTROL PANEL

Speaker

Connection the speaker system **1**

Speaker impedance for stereo connection is 2-8 Ohm and 4-8 Ohm for bridged mode connection.

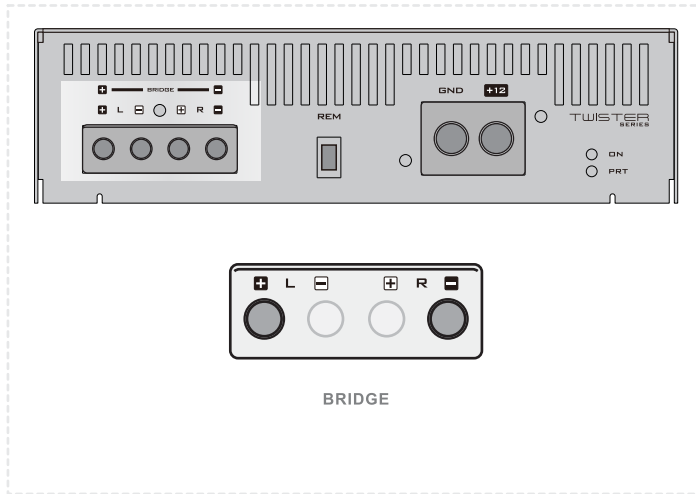

CONNECTIONS

The "Safety Measures General Rules" manual should be considered an integral part of this document. It is essential that all recommendations are observed in order to guarantee the safety of those responsible for installing and/or using the product.



Power supply

POSITIVE

Connect the "+12VDC" (4) terminal to the Positive pole of the battery via the external safety fuse.

NEGATIVE

Connect the "GROUND" (5) terminal firmly to a metal part of the vehicle free from any residue, using the shortest possible cable.

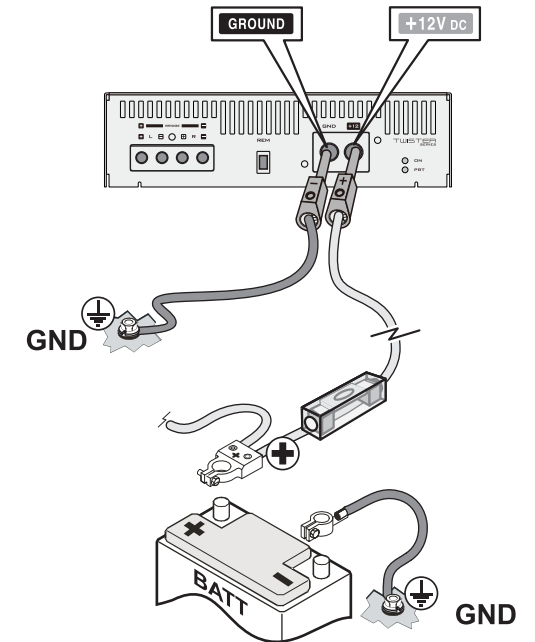

CONNECTIONS

Speaker

CONNECTING THE SPEAKER SYSTEM 1

Connect the speaker system to the speaker terminals (1). Depending on your configuration needs, perform the connection as follows:

A: STEREO

Loudspeakers connected in Stereophonic mode, on the right channel and on the left channel.

B: BRIDGED MONO

Loudspeakers connected in Monophonic mode taking the "bridged" signal from both channels.

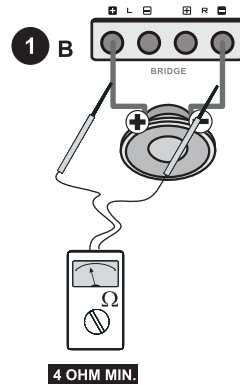
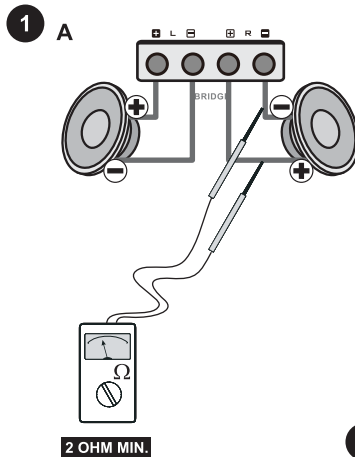
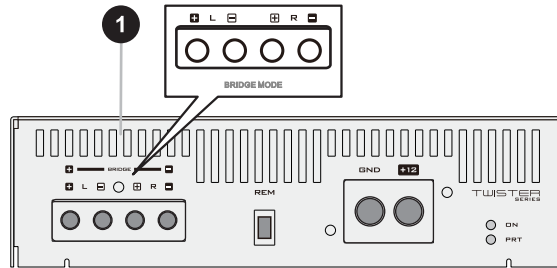

C: TRIMODE

Loudspeakers connected in both Monophonic and Stereophonic mode.

Output load impedance

Systems composed of several loudspeakers can be connected, as long as the overall impedance is not less than **2 Ohm** in Stereo configuration or **4 Ohm** in bridge Mono configuration.

In Trimode mode, the overall impedances of both the Stereo and Mono systems should not be less than **4 Ohm**.

Passive filters

Normally, is necessary to optimise the response of the various loudspeakers, using Passive Filters fitted with Capacitors and Inductors for audio use. Opposite is a table to help you identify the values of the components required: **L** for Inductors and **C** for Capacitors.

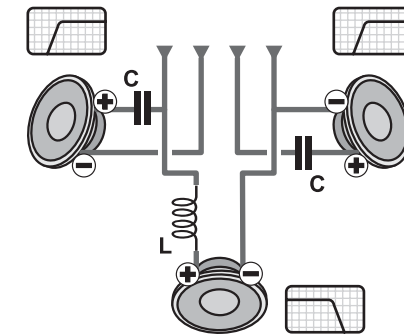

CUT F Hz	2 ohm		4 ohm	
	LmH	CµF	L mH	CµF
80	4.1	1000	8.2	500
100	3.1	800	6.2	400
130	2.4	600	4.7	300
200	1.6	400	3.3	200
260	1.2	300	2.4	150
400	.8	200	1.6	100
600	.5	136	1.0	68
800	.41	100	.82	50
1000	.31	78	.62	39
1200	.25	66	.51	33
1800	.16	44	.33	22
4000	.08	20	.16	10
6000	.051	14	.10	6.8
9000	.034	9.5	.068	4.7
12000	.025	6.6	.051	3.3

ADJUSTMENTS AND USE

First usage

BEFORE CONNECTING THE TERMINALS TO THE BATTERY, MAKE SURE THAT ALL CONNECTIONS HAVE BEEN MADE IN ACCORDANCE WITH THE GUIDES AND WITH THE RELEVANT DOCUMENTATION FOR THE DEVICES CONNECTED TO THE AMPLIFIER. SET VOLUME TO MINIMUM AND SWITCH-ON THE SOURCE.

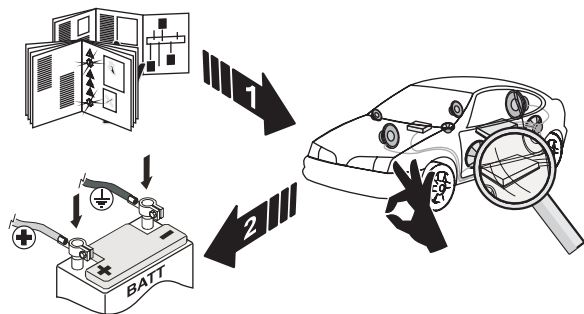

Indicator LEDs

The combinations of the green "POW" and red "PRO" warning lights indicate the operative status:

A Off

B On

Normal operation status.

C Overheating

Muting enforced due to overheating ($T > 90^{\circ}\text{C}$). The amplifier will resume as soon as the temperature returns below 70°C .

D Output short circuit

Muting enforced due to an output short-circuit or unacceptable low impedance load. The amplifier will resume correct operation as soon as normal output conditions are restored.

E GND ground fault

Muting enforced due to a GND circuit anomaly. The amplifier will resume status as soon as the GND circuit returns to normal.

F Main fault

Serious malfunction, non-recoverable condition.

	ON	PRT
A	○	○
B	☀	○
C	○	☀
D	○	☀
E	○	☀
F	○	☀

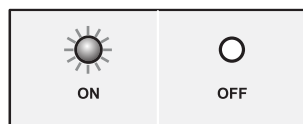

5

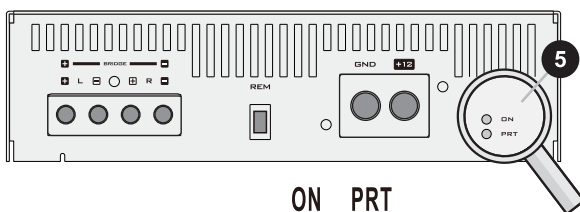

ADJUSTMENTS AND USE

Sensitivity adjustment

In order to harness all the power available, you must match the amplifier's sensitivity to the output voltage of the source, the value of which depends on both the constructional specifications and the level of the recording being played (CD, DVD, etc.). The manufacturer's indications refer to the reproduction of a signal recorded at maximum strength (0db); however, the majority of recordings on the market do not reach this level. This implies that, in general, the output voltage of the source is below the nominal value.

To set the sensitivity correctly, follow the procedure described below:

A: Using a flat-tip screwdriver, turn the potentiometers anti-clockwise for the sensitivity, until you reach the end of the range.

B: Turn the volume of the Source down to the minimum.

C: Turn on the Source.

D: Position the car radio volume to 3/4 of its range.

E: Turn the sensitivity potentiometers clockwise one by one until you hear the first signs of sound distortion.

8

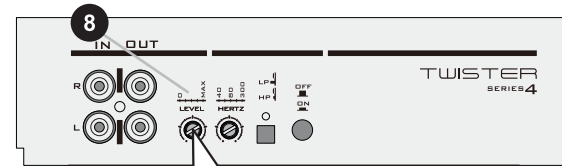

A

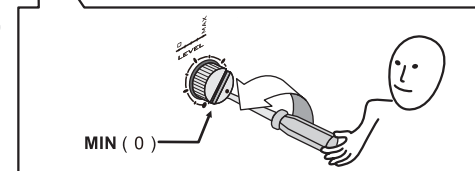

B

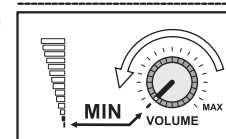

C

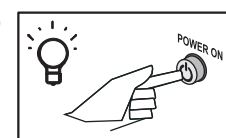

D

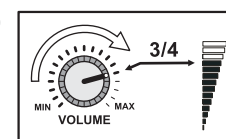

E

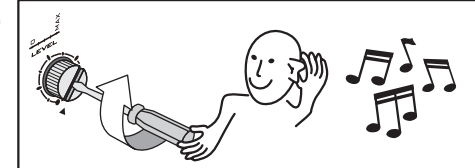

The amplifier is ready to supply all the power!



**CONFIGURATION
SUGGESTIONS**

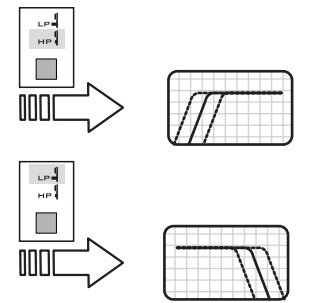
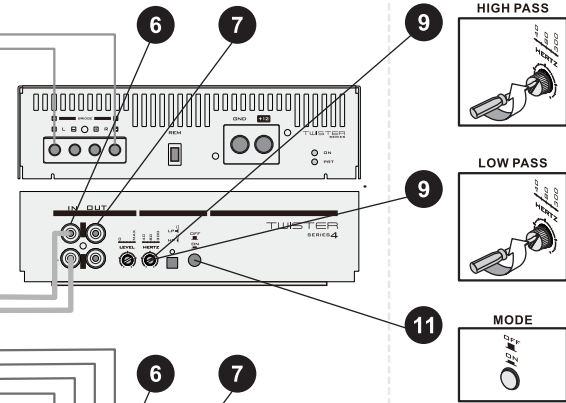
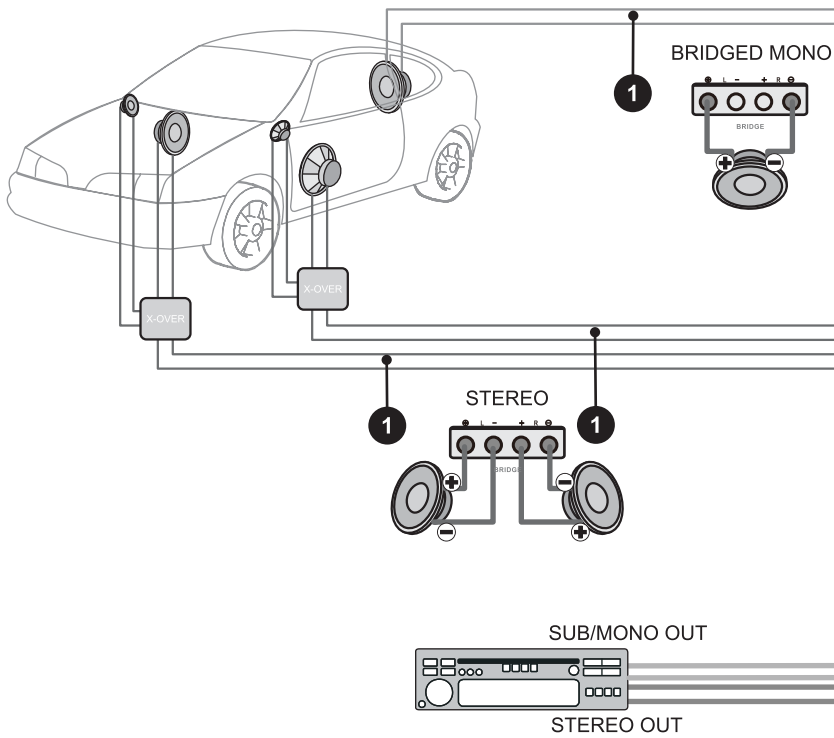
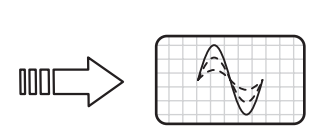
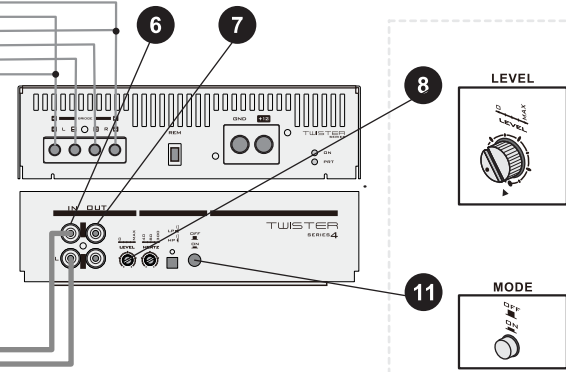
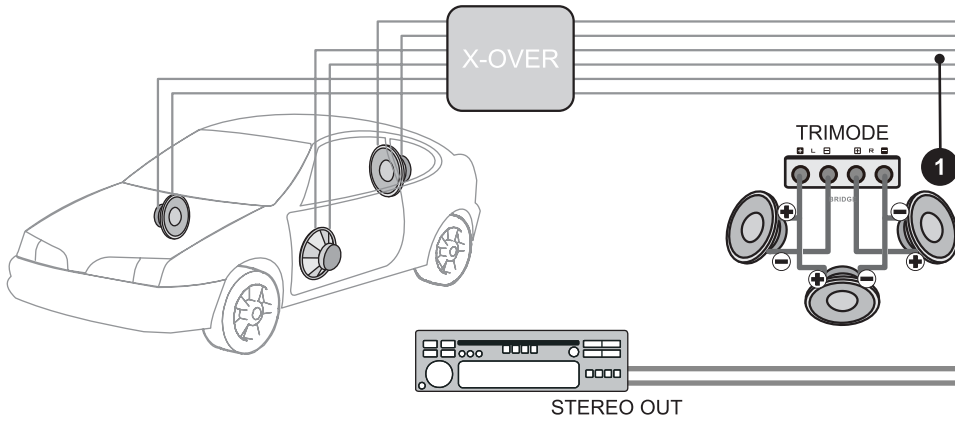

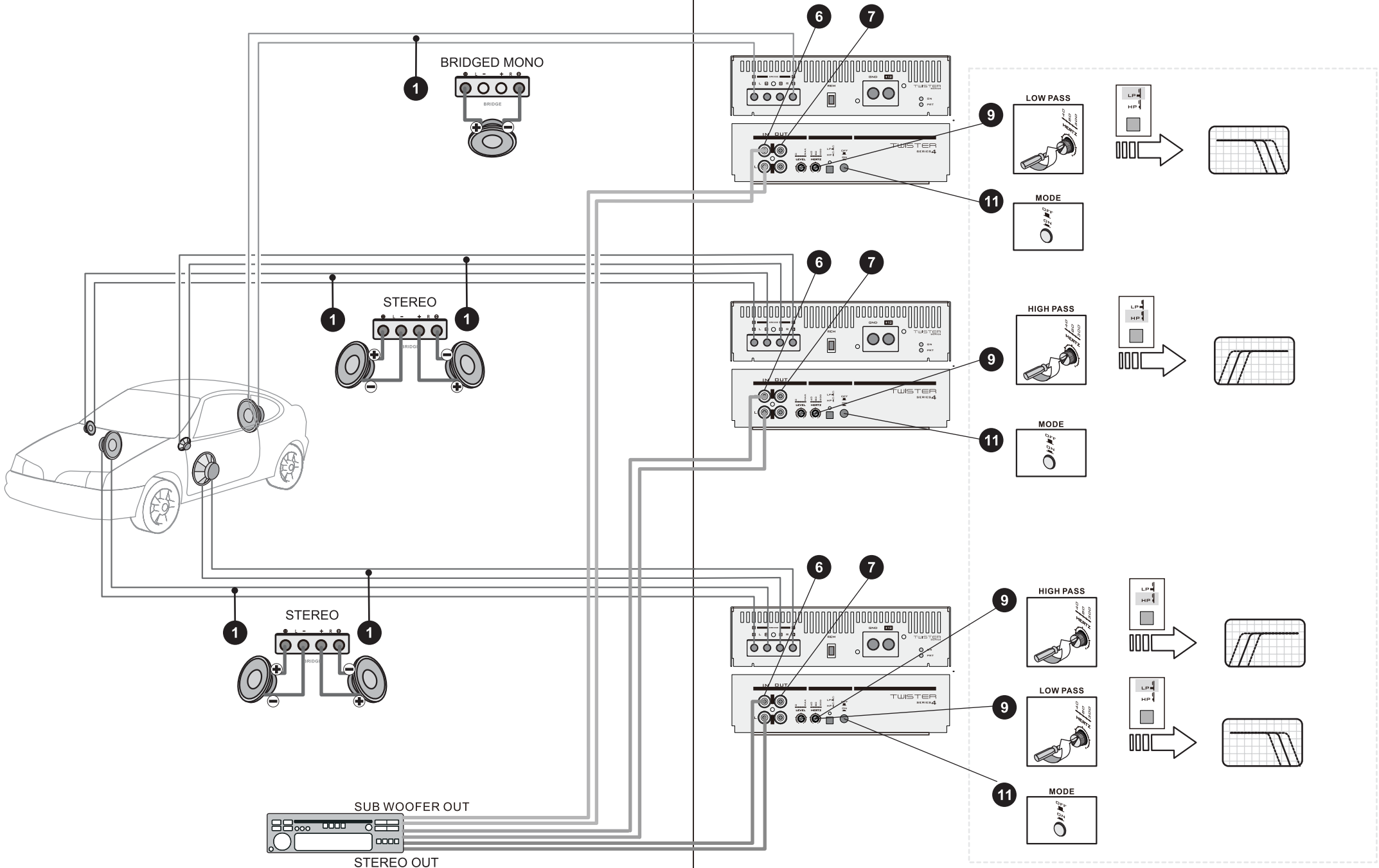

MAINTENANCE

Fuse replacement

Proceed with the fuse replacement making sure you have turned off the Source beforehand. Remove the burnt fuse and replace it with a new one of the same type and capacity (same maximum current).

After-sales service

For all After-Sales Service requirements, contact the Retailer you purchased the Amplifier from, to activate the A.T.R.I. procedure.

A.T.R.I.

The A.T.R.I. is a specialised centre in charge of all technical servicing and repair work in Italy. The service is offered by G.T.trading to guarantee top quality, rapid servicing for the best performance of all G.T.trading products at all times. Each product is analysed, repaired and tested exclusively in-house. Every product is automatically updated to the latest version through the replacement of all obsolete parts, including those not directly concerned by the repair.

Product identification

In all communications with G.T. Trading or authorised Retailers, always mention the model and serial number marked underneath the Amplifier.

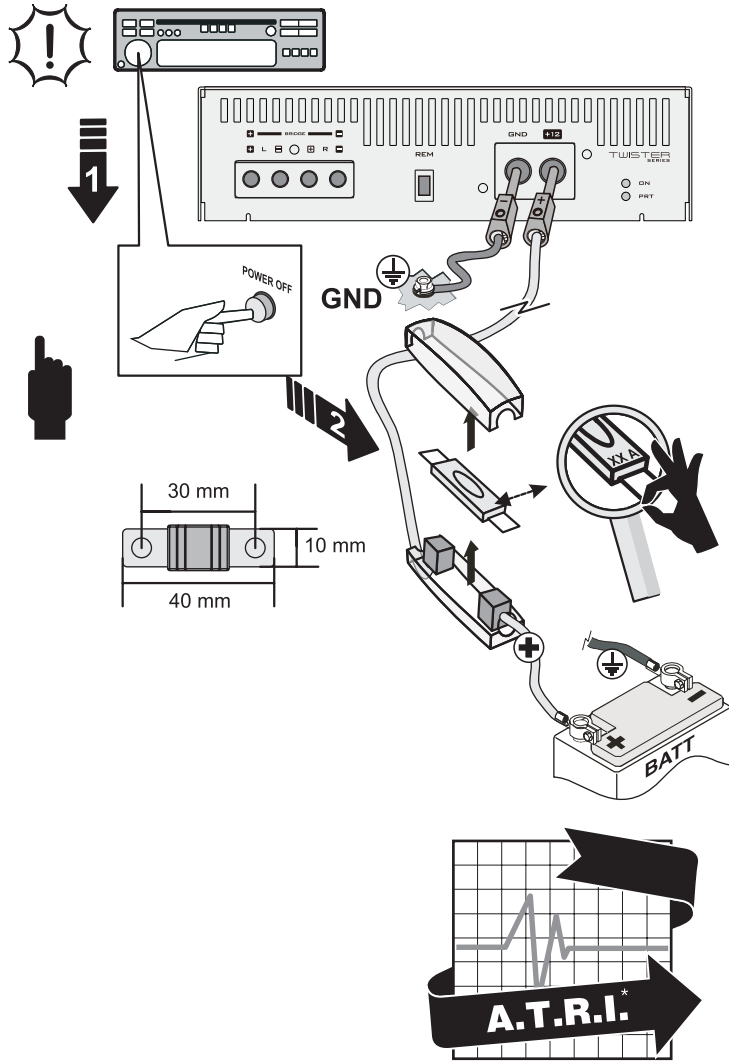

FAULTS AND TROUBLESHOOTING

ALL TROUBLESHOOTING OPERATIONS SHOULD BE CARRIED OUT BY A QUALIFIED TECHNICIAN ONLY WHO HAS READ AND UNDERSTOOD THE USER'S MANUAL IN FULL.



Source on, no sound, "POW" and "PRO" LEDs off or blinking.

FAULT:

1. There is no voltage on the "REM" terminal.
2. The Power supply circuit is unsuitable.
3. The fuse/s are burnt
4. The voltage at the power supply terminals of the amplifier is below 7 VDC.

REMEDY:

1. Check and reset the remote switch-on connection.
2. Check and reset the cable and the solidity of connections.
3. Replace the fuse(s) with (a) new one(s) of the same type and value.
4. Recharge the battery and check/reset the power supply circuit.

Source on, no sound, "POW" LED off and "PRO" LED on.

FAULT:

1. The amplifier has malfunctioned and the protection has been irreversibly activated.

REMEDY:

1. Contact your retailer to activate the Technical Service procedure.

